



University  
of Pardubice  
Faculty  
of Electrical Engineering  
and Informatics

# UHF Wide Band Antenna

Tomáš Shejbal

# INTRODUCTION

---

The device is a wideband half wave dipole antenna for transmission and reception of signals in 300 – 500 MHz frequency band.



- design wideband antenna for center frequency 400 MHz with span 200 MHz and beam widths minimal 60 degrees in azimuth and elevation
- compute dimensions of an antenna
- choose type of an antenna
- create model in the CST Microwave Studio
- optimization for beam widths and return loss
- create data for fabrication
- verify antenna parameters by measurement return loss and radiation pattern
- analyze differences between simulation and reality

# OBJECTIVES

- compute the dimension of an antenna
- create model in CST Microwave Studio
- optimization of simulation model
- create data for fabrication
- verify antenna parameters by measurement

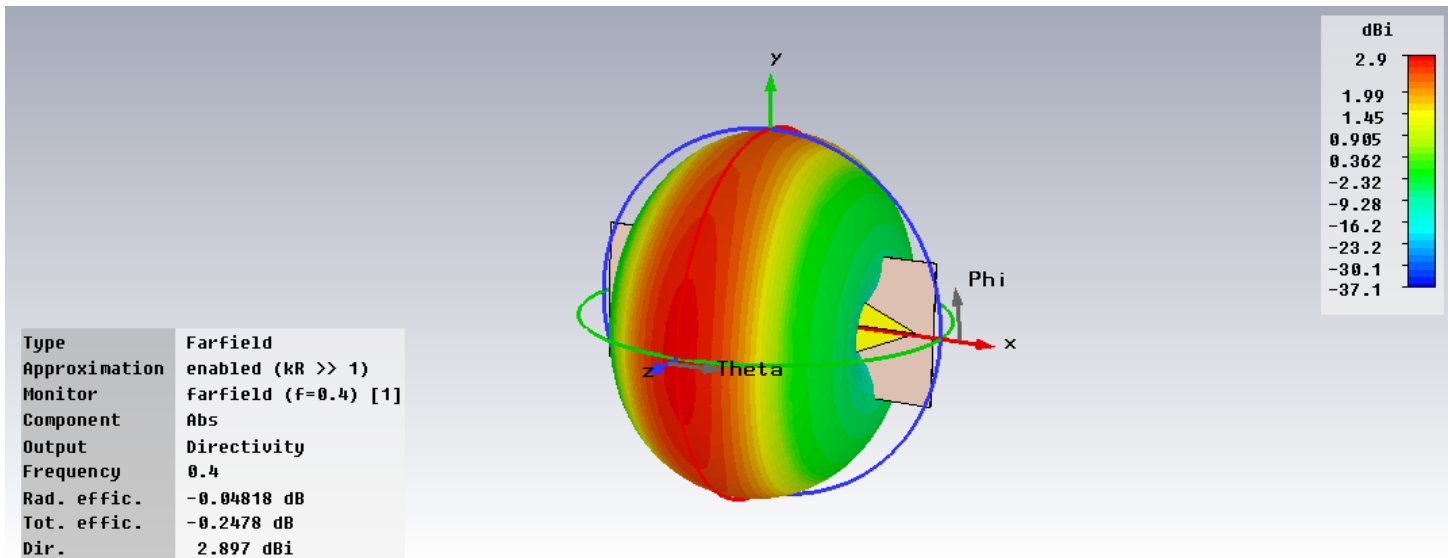

# Antenna Topology

The antenna is designed for frequency band 300 – 500 MHz. The microstrip technology with FR4 substrate is used. There are input microstrip line and balun which distributes input power to both arms of the dipole. The arms of the dipole give a shape to radiation pattern with beam width 60 degrees (lowest value) at horizontal plane and 180 degrees at vertical plane. The bottom side of the substrate is without cooper, there is only small part of the cooper under input microstrip line and balun. Reason for that is input impedance 50  $\Omega$ .

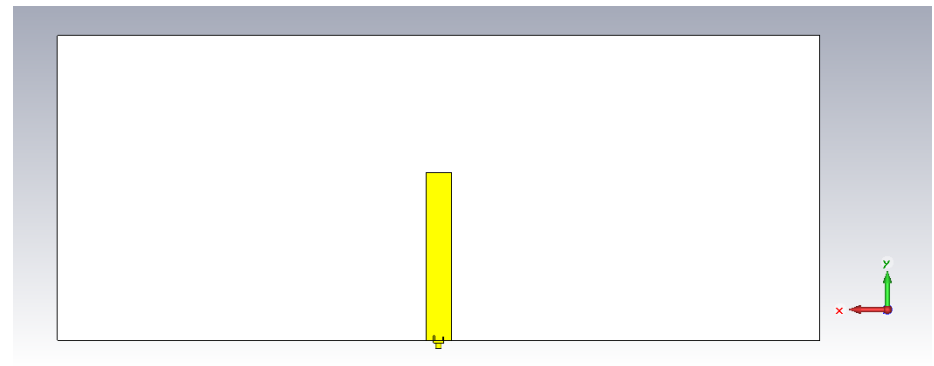
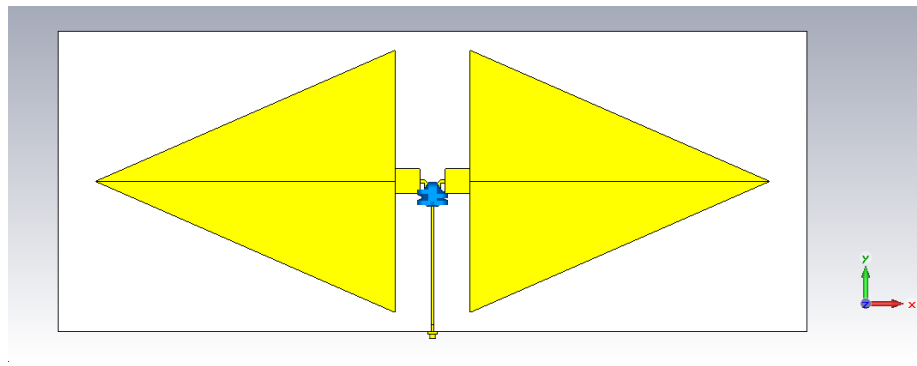

# MATERIAL & METHOD

- substrate FR4
  - thickness: 1.5 mm
  - width: 600 mm
  - height 240 mm



The antenna was measured at far zone. Workspace for automatic antenna measurement was used (a part of the same project).

# RESULTS

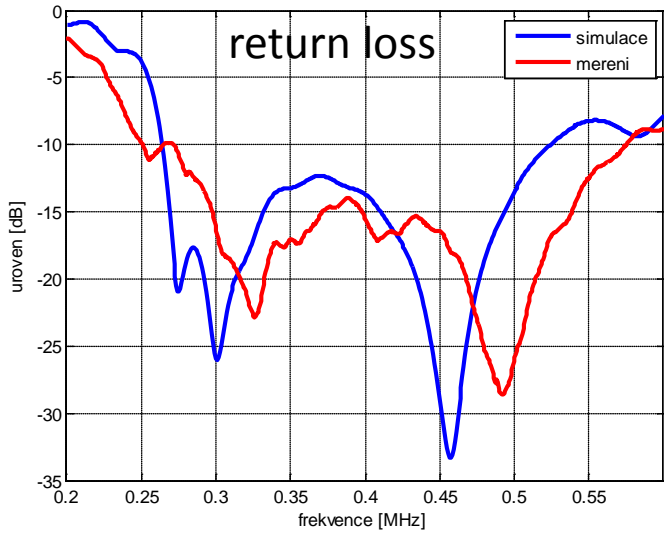

- S11 in the full frequency band: -14dB
- azimuth beam width: 57° – 78°

horizontal radiation patterns

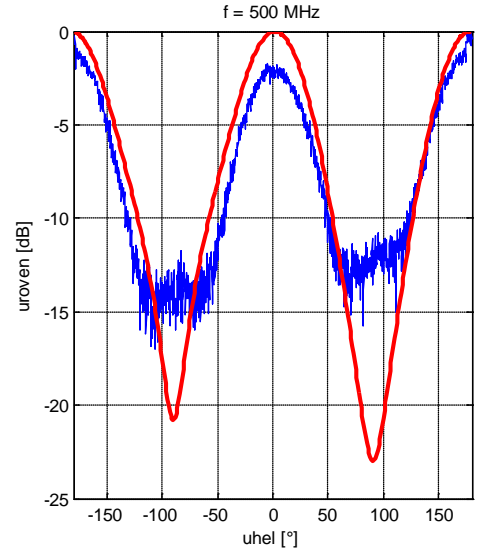
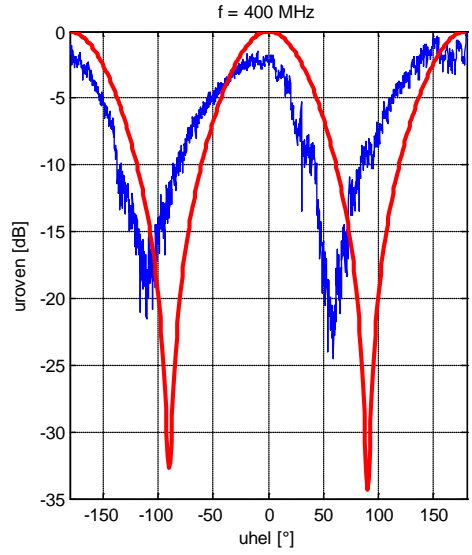
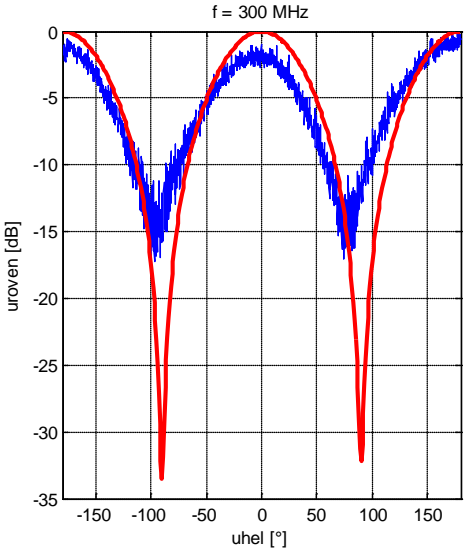

# ACKNOWLEDGEMENT & CONTACT

Tomáš Shejbal  
tomas.shejbal@student.upce.cz  
Department of Electrical Engineering  
Faculty of Electrical Engineering and Informatics  
University of Pardubice  
Czech Republic

<http://www.upce.cz/en/fei/ke.html>

The described research was supported by the Internal Grant Agency of University of Pardubice, the project No. SGFEI 09/2013.

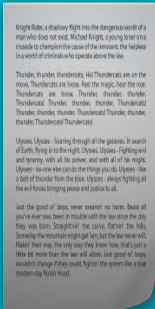

Knights flew a shadowy fight into the dangerous world of a man who does not exist. Michael Knight, a young boy on a mission to change the world for the better, the highest in a world of criminals who operate above the law.

Thunder, thunder, thunder, All Thunderers are on the move. Thunderers are here, feel the rage, feel the rage. Thunderers are here, Thunder, thunder, thunder. Thunderous! Thunder, thunder, thunder, Thunderous! Thunder, thunder, Thunderous! Thunder, thunder, Thunderous! Thunder, thunder, Thunderous! Thunder, thunder, Thunderous! Thunder, thunder, Thunderous! Thunder, thunder, Thunderous! Thunder, thunder, Thunderous!

Uppas, Uppas - Scouring through all the galaxies, in search of Earth, flying in the night, Uppas, Uppas - Fighting and and trying with all its power, and with all its might, Uppas - no-one else can do for things you do, Uppas - the a bolt of thunder from the blue, Uppas - always fighting of the evil forces, bringing peace and justice to all.

Just the kind of hero, when needed, no hero. Some of you've ever been in trouble with the law since the day they was born. Stay together, the cops, partner the 110. Sometimes the moment might get you back the way we will. Hear it now, the way they know how that get a line of men from the wall, close, the kind of hero, wouldn't change if they could, fight the system like a true modern-day Robin Hood.